

LMS Fowler 4F Etched Parts Identification



SHEET B

Main components that are etched on 0.015" brass.

Note that the main boiler section is identified as part 25 but this is removed from the sheet and pre rolled and should be found wrapped in tissue paper within the kit box.

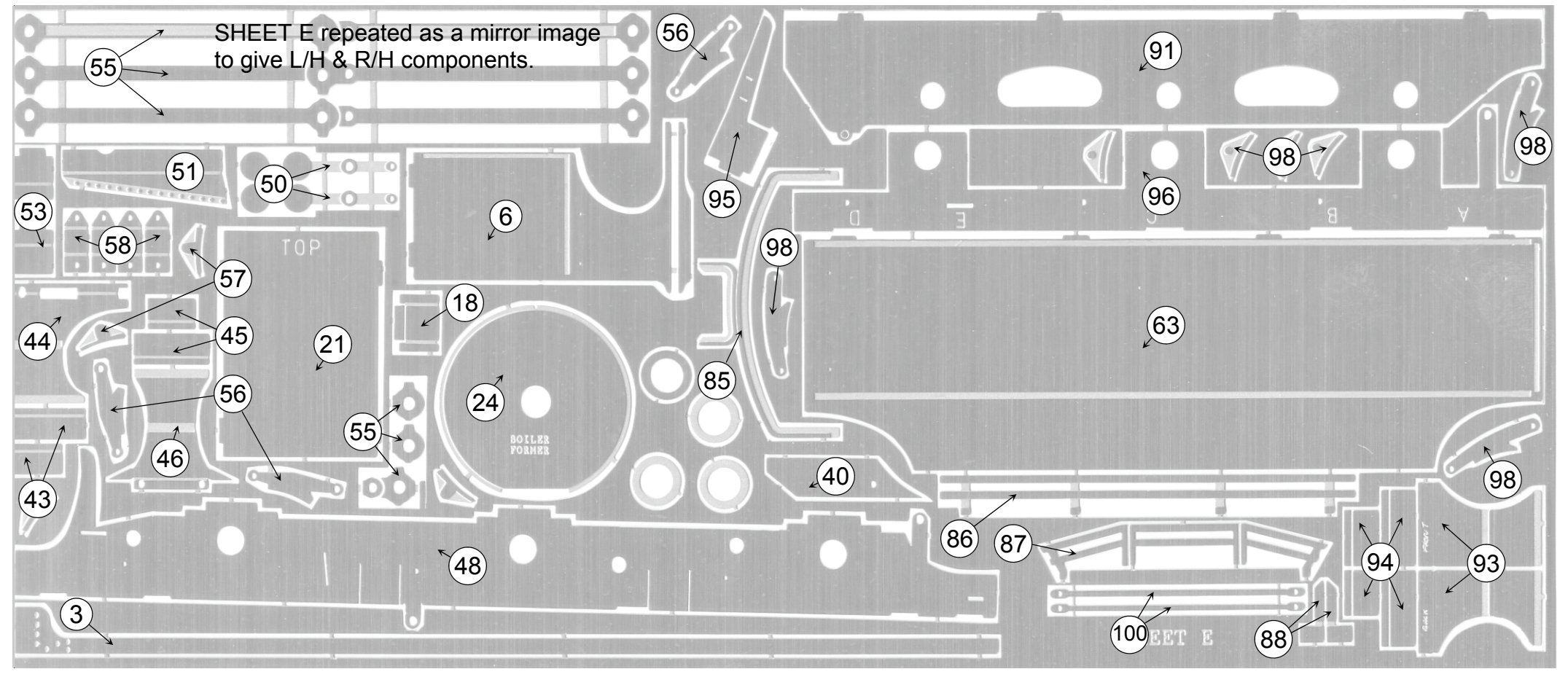
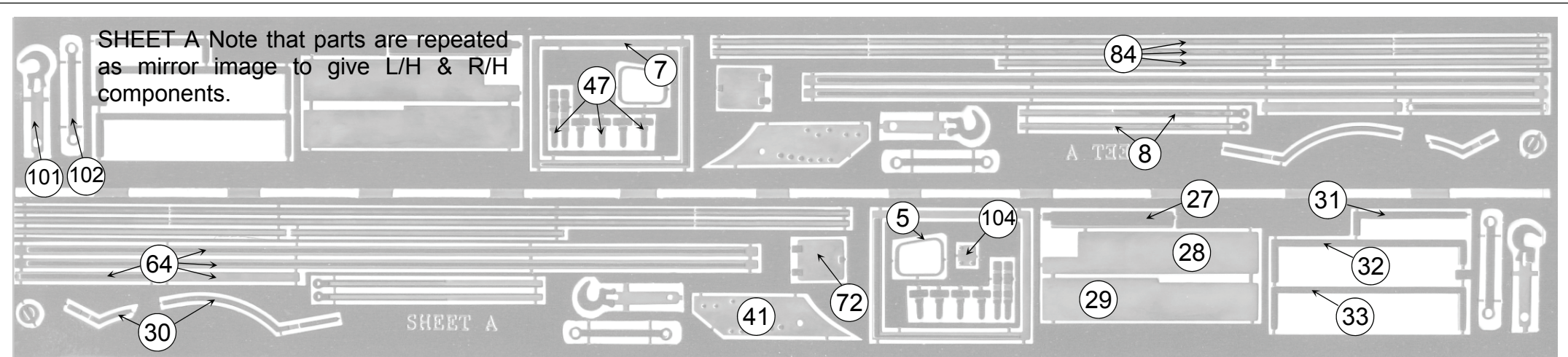

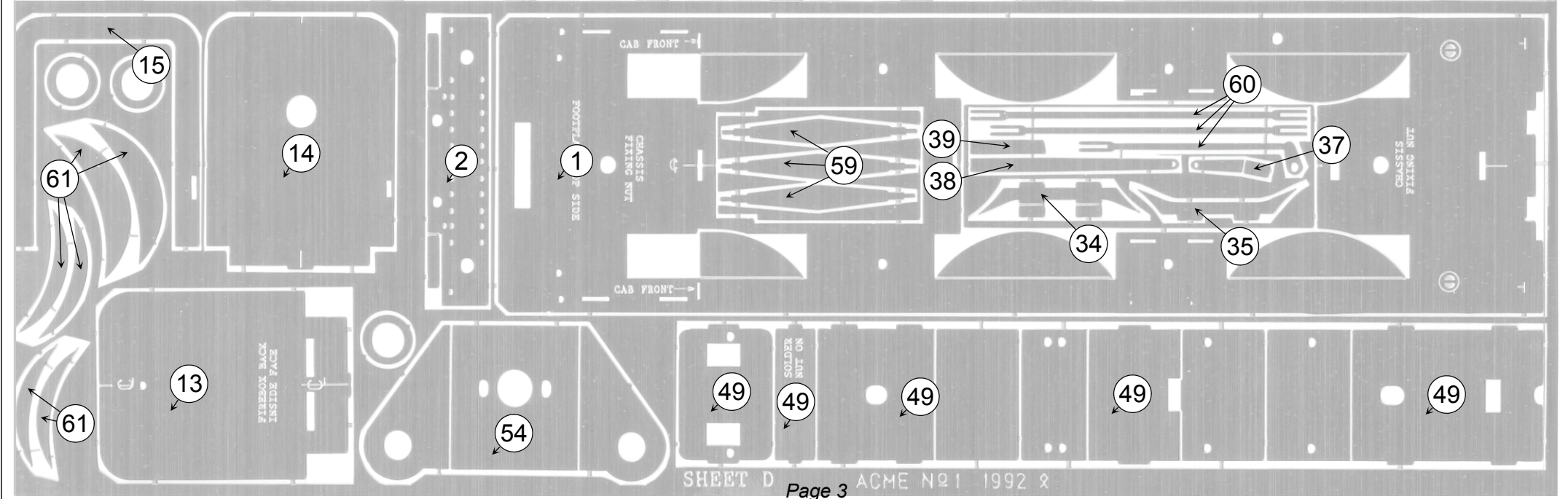
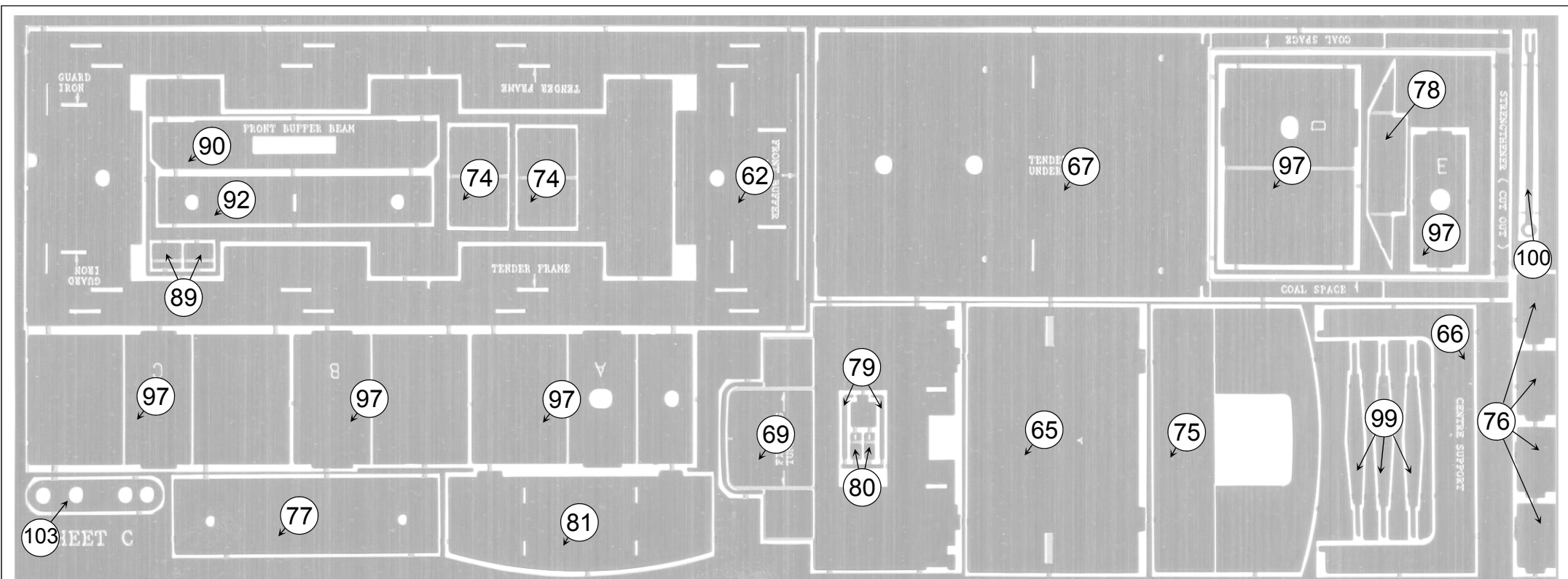

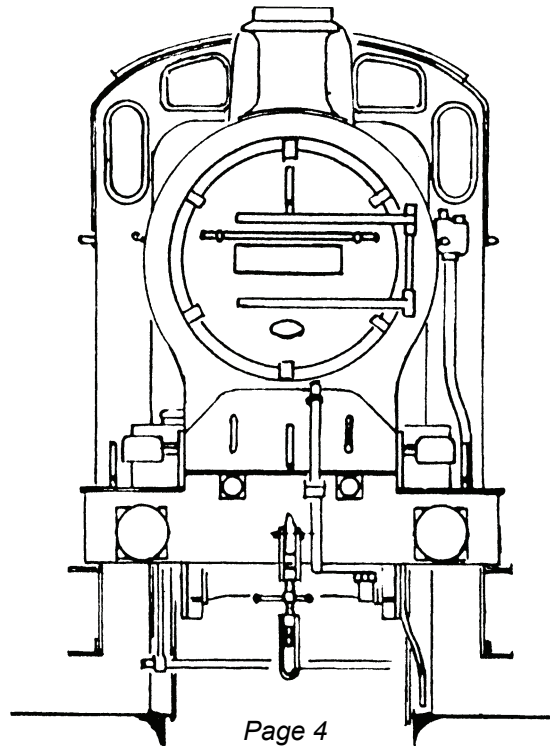
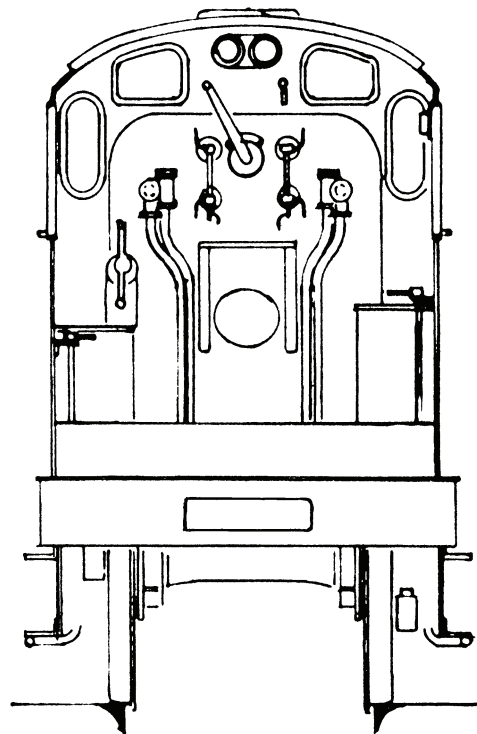
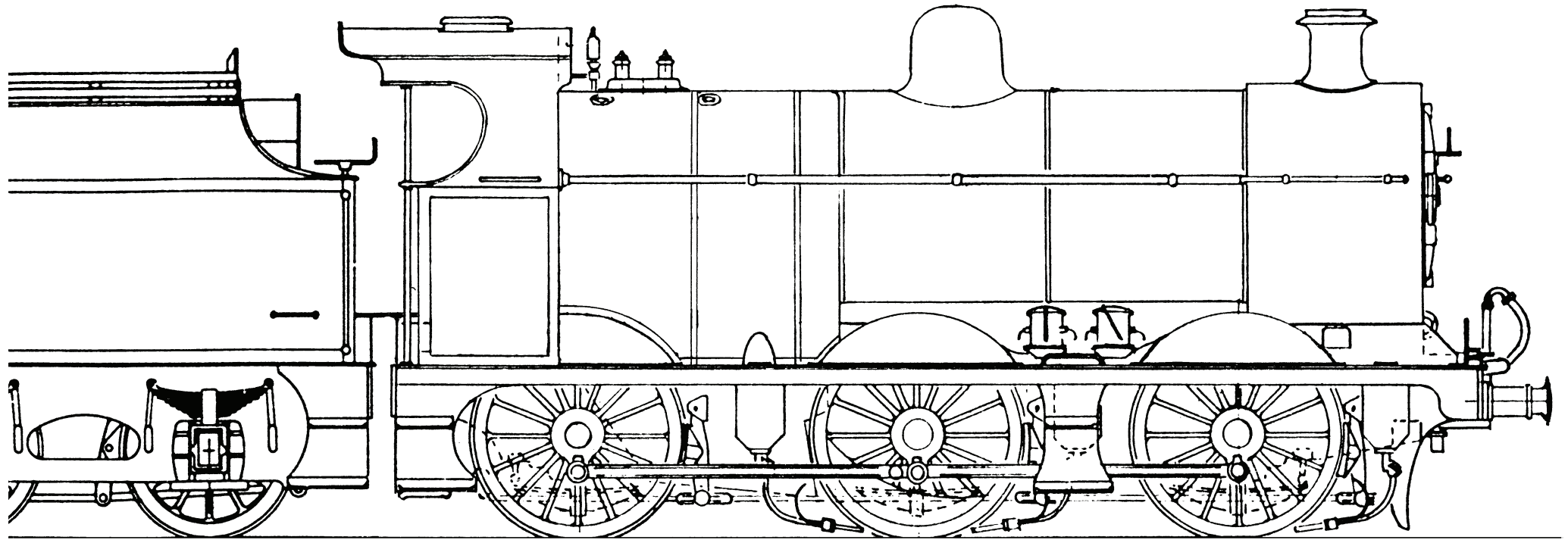

**CONNOISSEUR
MODELS
LMS FOWLER 4F
FREIGHT ENGINE**

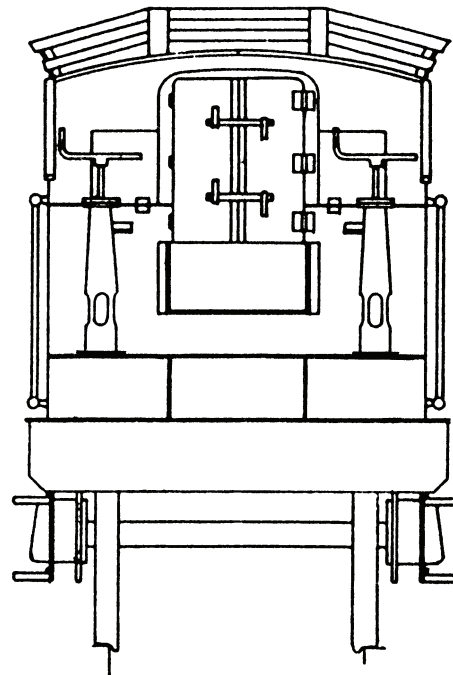
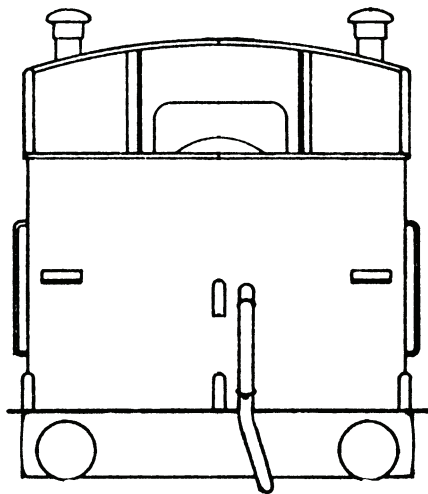
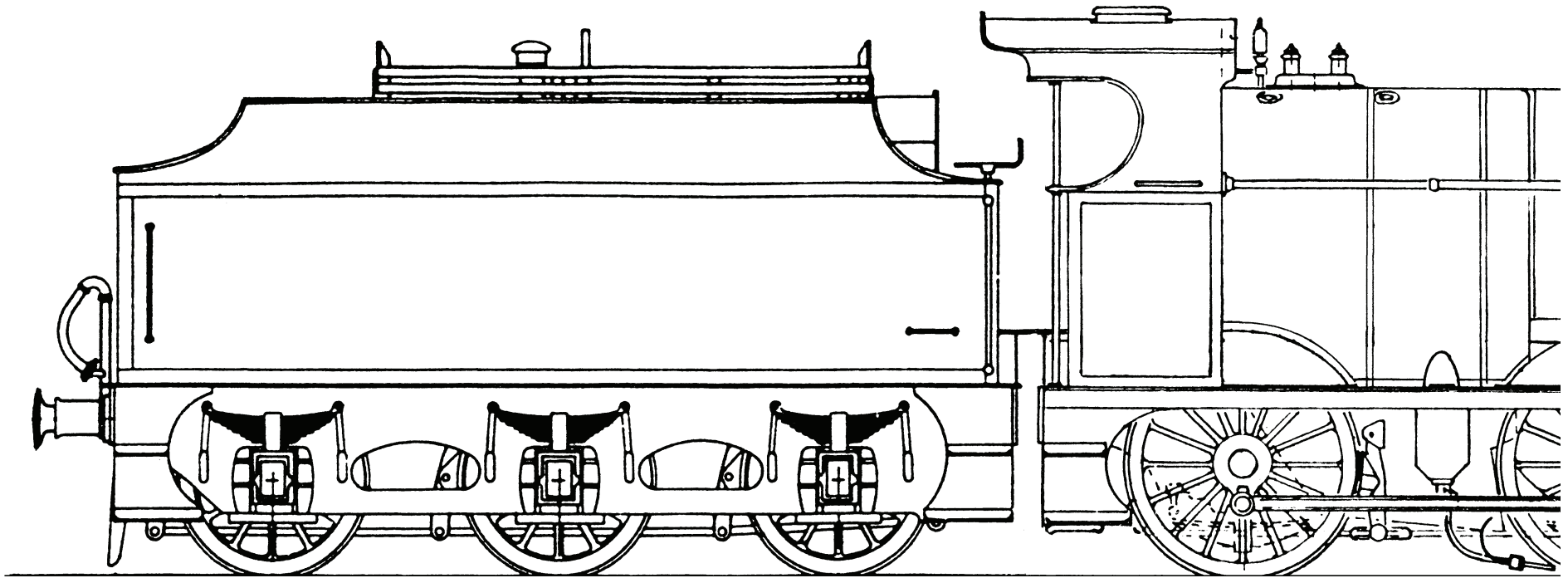

**CONNOISSEUR
MODELS
LMS FOWLER 4F
FREIGHT ENGINE
3500 GALLON
TENDER**

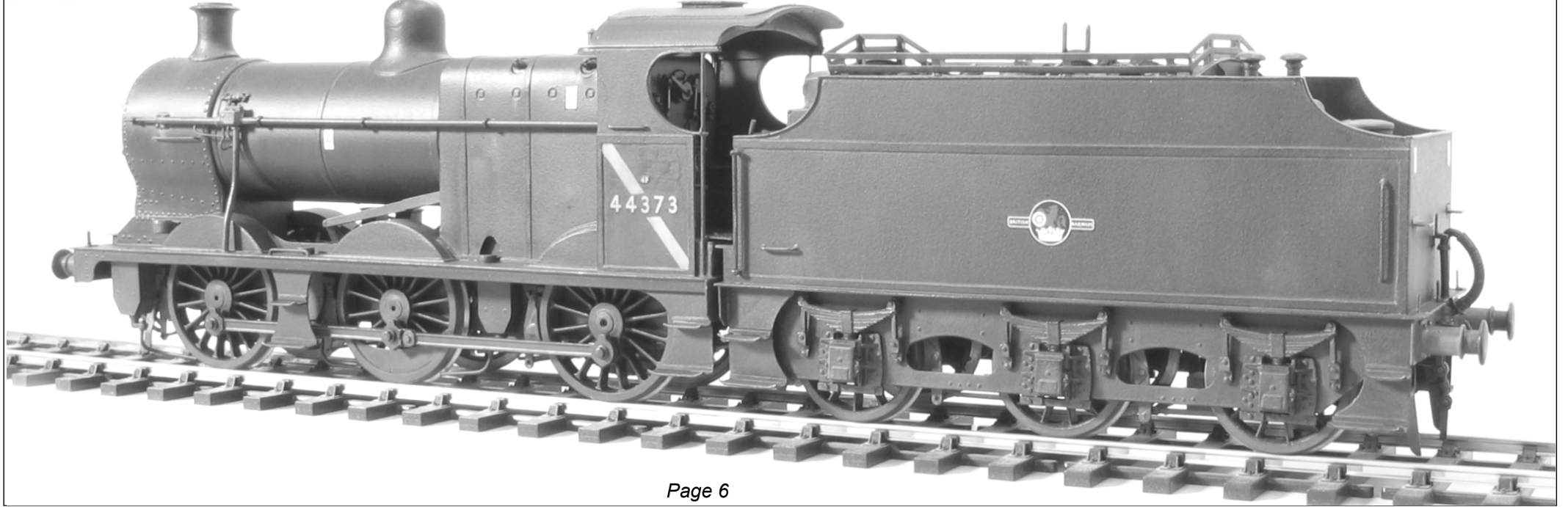
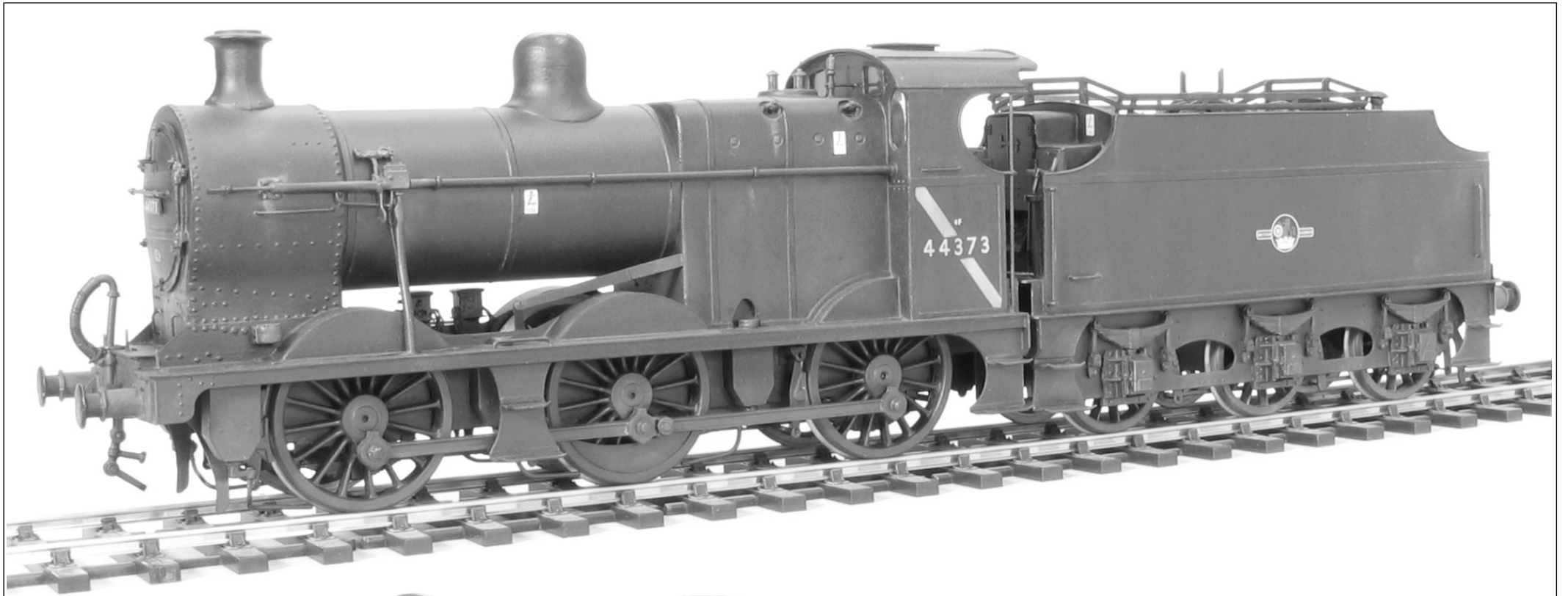

LMS Fowler 4F Parts Identification



Tender Handbrake & Water Pickup Operating Stanchions X 2

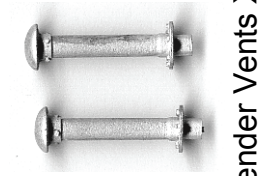

Tender Vents X 2

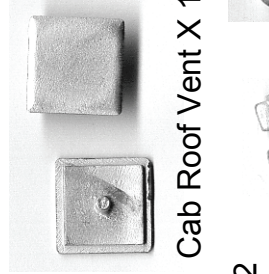

Cab Roof Vent X 1

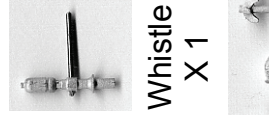

Whistle X 1

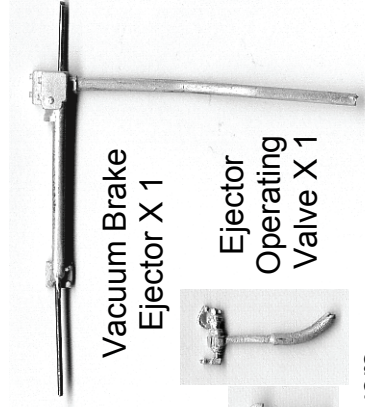

Vacuum Brake Ejector X 1

Ejector Operating Valve X 1



Sandbox Sand Chambers X 6



Valve Covers X 2



Safety Valves X 2

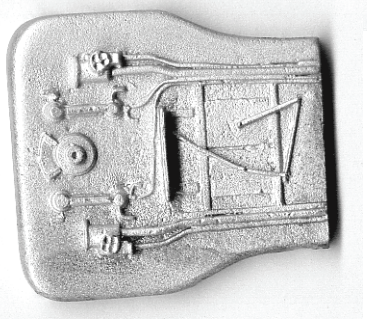

Backhead X 1

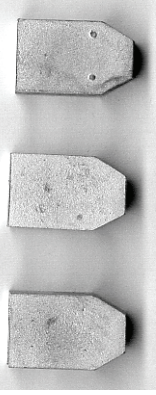

Mudhole Covers Early Type X 4



Mudhole Covers Later Type X 4



Sandboxes Narrow X 4, Wider X 2

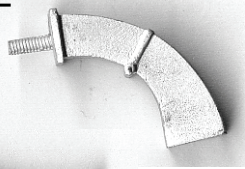

Tender Water Pickup Scoop X 1

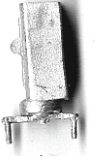

Screw Reverser X 1



Regulator Handle X 1



Anti Vacuum Valves X 2



Steam Heat Pipe X 2

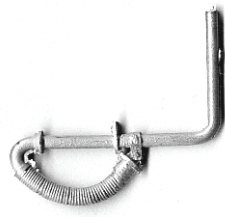

Vacuum Pipe X 2



Sandbox Filler Caps Raised X 4
Flush X 2

Lubricator, Front Handle & Operating Ratchet X 2

When I make the series of moulds required to produce a full set of castings for a kit. I tend to repeat some of the smaller castings to provide extras to cover against failure or breakage.

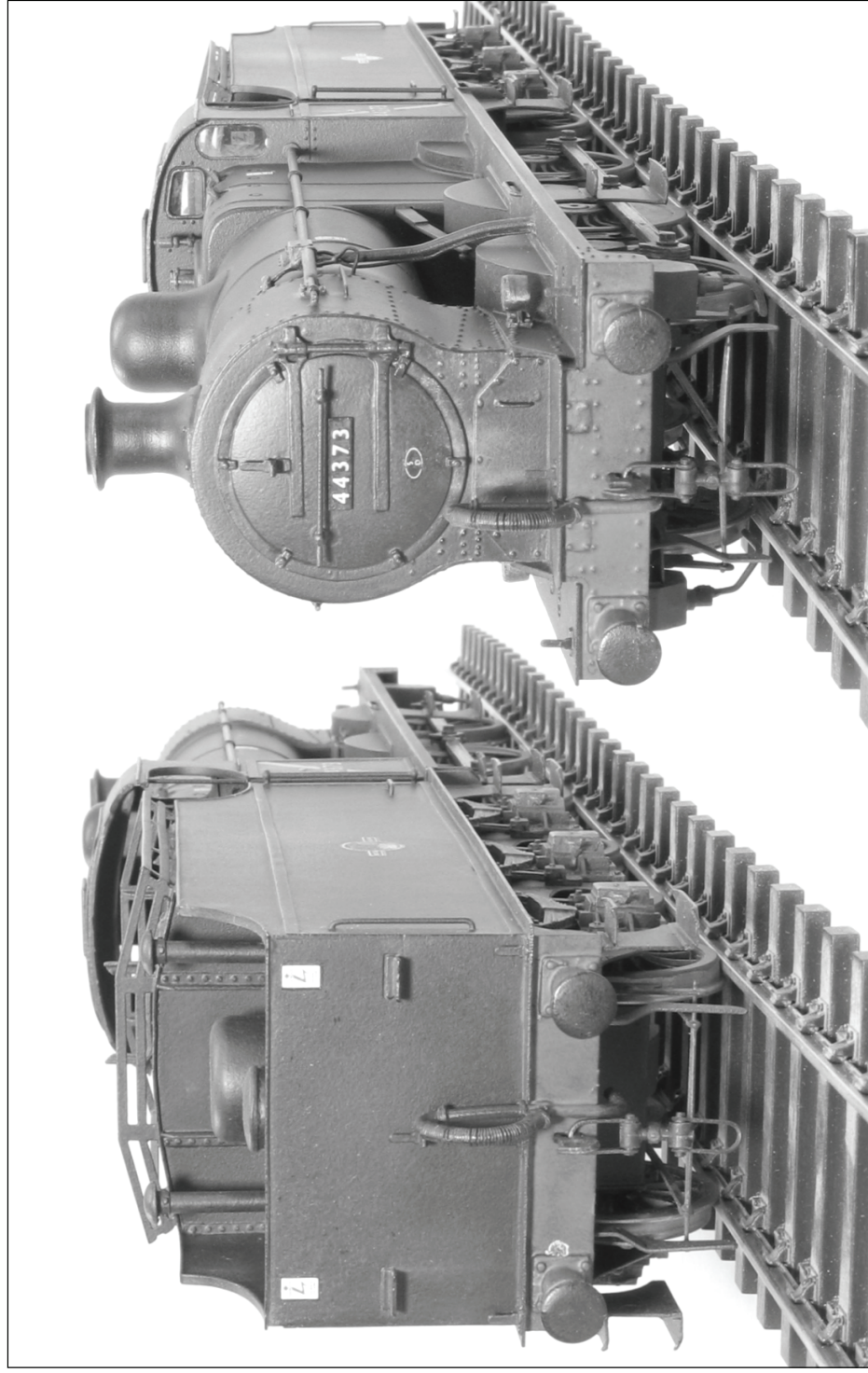

LMS Fowler 4F Parts Identification

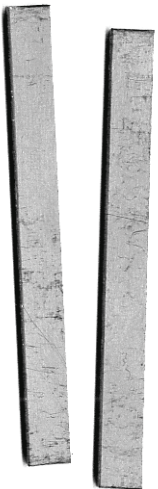

Printed Circuit Board Strips
For Use With Wire Wiper Pickups



12 X Brass Axle Bearings.



6BA Short Brass Screws X 4
6BA Brass Nuts X 4
For chassis to body fixing.

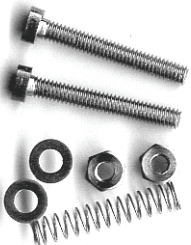

6BA Long Brass Screws X 2
6BA Brass Nuts X 2
6BA Washers X 2
Spring X 1
For loco to tender coupling



Split Pins X 18



Electrical Wire
For Pickups.
1 X 18" Black
1 X 18" Red



Coupling Centres X 2

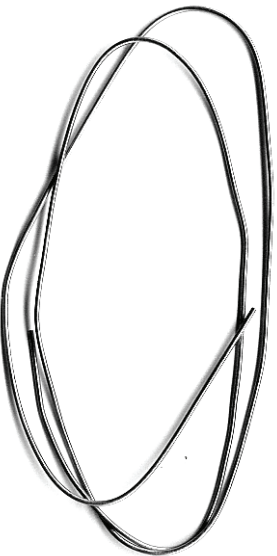

Tinned Soft Copper Wire 22swg Three Turns.
Tinned Soft Copper Wire 20swg Three Turns.
Clamp one end in vice and pull other end with pliers to straighten.

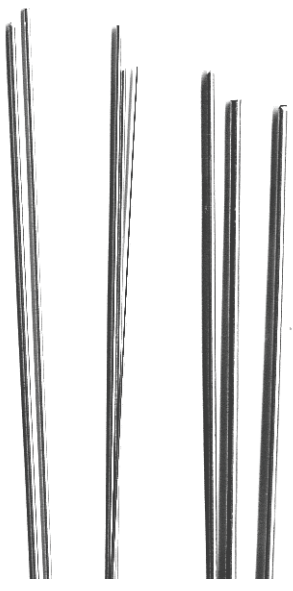

Selection of Wire and Rod

1.6mm dia Brass Rod X 4"
1.6mm dia Brass tube X 12"
1.8mm dia Copper Rod X 1" (for coupling rod joint pin
0.7mm dia Brass Wire 10" long X 6
0.9mm dia Brass Wire 10" long X 4
0.45mm dia Spring Brass Wire 10" long (for use as wire wiper pickups) X 2



Tender Water Pickup

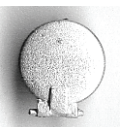

Dome X 1

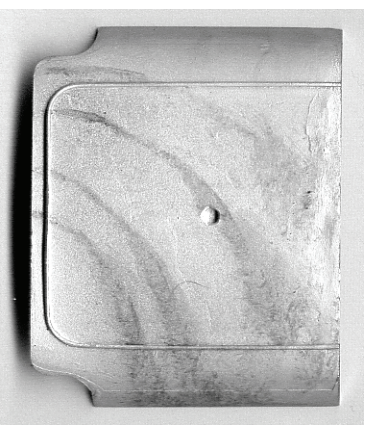

Cab Roof X 1



Chimney X 1
LMS Type

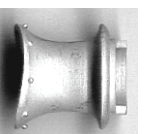

Chimney X 1
Midland Type

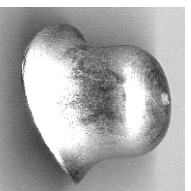

Dome X 1
Short

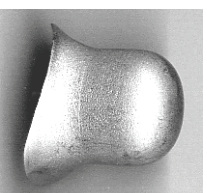

Dome X 1
Tail



Safety Valve
Base X 1

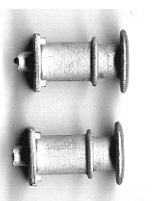

Buffers X 4

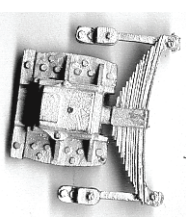

Tender Axle
Boxes X 6

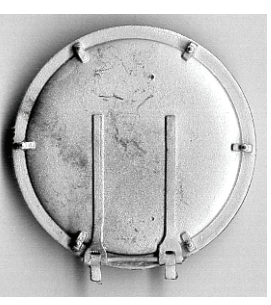

Smokebox Door X 1

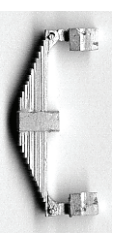

Loco Frame
Springs X 6

Cab Gauges 1 X large 1 X small